

Multi-port 10/100/1000T 802.3bt PoE + 4-Port 10G SFP+ Managed Ethernet Switch



Perfect Managed PoE++ Switches with Advanced L2/L4 Switching and Security

PLANET GS-4210-16UP8T4X and GS-4210-24UP4X Gigabit 802.3bt PoE++ Managed Switches feature PLANET intelligent PoE functions to improve the availability of critical business applications. They provide IPv6/IPv4 dual stack management and a built-in L2/L4 Gigabit switching engine. The GS-4210-16UP8T4X comes with 16 10/100/1000BASE-T 802.3bt PoE++ ports, 8 additional Gigabit copper ports, and 4 10 Gigabit fiber ports, with a total power budget of 420 watts. The GS-4210-24UP4X comes with 24 10/100/1000BASE-T 802.3bt PoE++ ports and 4 10 Gigabit fiber ports, with a total power budget of 720 watts. The GS-4210-Series offers a quick, safe, and cost-effective 802.3bt PoE++ network solution for small businesses and enterprises.

Cybersecurity Network Solution to Minimize Security Risks

The cybersecurity feature included to protect the switch management in a mission-critical network virtually needs no effort and cost to install. Both SSHv2 and TLSv1.2 protocols are utilized to provide strong protection against advanced threats. The network administrator can now construct highly-secure corporate networks with considerably less time and effort than before.



Redundant Ring, Fast Recovery for Critical Network Applications

The GS-4210-Series supports redundant ring technology and features strong, rapid self-recovery capability to prevent interruptions and external intrusions. It incorporates advanced ITU-T G.8032 ERPS (Ethernet Ring Protection Switching)

Physical Port

- **GS-4210-16UP8T4X**
 - 16 10/100/1000BASE-T ports with 95W 802.3bt PoE++ injector function (Ports 1 to 16)
 - 8 10/100/1000BASE-T ports (Ports 17 to 24)
 - 4 10GBASE-SR/LR SFP+ slots, backward compatible with 100/1G/2.5GBASE-X SFP transceivers (Ports XG1 to XG4)
 - RJ45 to DB9 console interface for switch basic management and setup
- **GS-4210-24UP4X**
 - 24 10/100/1000BASE-T ports with 95W 802.3bt PoE++ injector function (Ports 1 to 24)
 - 4 10GBASE-SR/LR SFP+ slots, backward compatible with 100/1G/2.5GBASE-X SFP transceivers (Ports XG1 to XG4)
 - RJ45 to DB9 console interface for switch basic management and setup

Switching

- Hardware-based 10/100Mbps (half/full duplex), 1000Mbps (full duplex), auto-negotiation and auto MDI/MDI-X
- IEEE 802.3x flow control for full duplex operation and back pressure for half duplex operation
- 16K MAC address table size
- 12K jumbo frame
- Automatic address learning and address aging

Power over Ethernet

- Compliant with IEEE 802.3bt Power over Ethernet Plus Plus
- 16/24 ports supporting IEEE 802.3bt PoE++ with each offering up to 95 watts (ports 1-16 / ports 1-24)
- Total PoE power budget of 420/720 watts
- Automatic detection of powered devices (PD)
- Built-in circuit protection to prevent power interference between ports
- Remote power feeding up to 100 meters in standard mode and 250 meters in extend mode
- Advanced PoE management capabilities:

technology, Spanning Tree Protocol (802.1s MSTP) into customer's network to enhance system reliability and uptime in various environments.

ERPS Ring for Video Transmission Redundancy

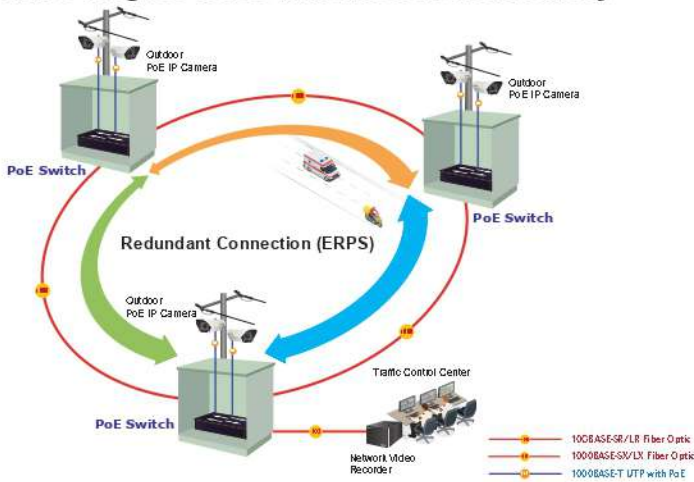

802.3bt PoE++ 95-watt Power over 4-pair UTP Solution

As the GS-4210-Series adopts the IEEE 802.3bt PoE++ standard technology, it is capable to source up to **95 watts** of power by using all the four pairs of standard Cat5e/6 Ethernet cabling to deliver power and full-speed data to each remote PoE compliant powered device (PD). Its power capability is three times more than that of the conventional 802.3at PoE+ and it is an ideal solution for those high power consuming network PDs, such as:

- PoE PTZ speed dome cameras
- Network devices
- Thin clients
- AIO (all-in-one) touch PCs, point of sale (POS) and information kiosks
- Remote digital signage displays
- PoE lightings



- Total PoE power budget control
- Per port PoE function enable/disable
- PoE port power feeding priority
- Per PoE port power limitation
- Detection of PD classification
- Intelligent PoE features
 - PD alive check
 - PoE schedule
 - Scheduled power recycling

Layer 2 Features

- Supports VLAN
 - IEEE 802.1Q tagged VLAN
 - Provider bridging (VLAN Q-in-Q, IEEE 802.1ad) support
 - Protocol VLAN
 - Private VLAN (Protected port)
 - Management VLAN
 - GVRP
- Supports Spanning Tree Protocol
 - STP (Spanning Tree Protocol)
 - RSTP (Rapid Spanning Tree Protocol)
 - MSTP (Multiple Spanning Tree Protocol)
 - STP BPDU Guard, BPDU Filtering and BPDU Forwarding
- Supports Link Aggregation
 - IEEE 802.3ad Link Aggregation Control Protocol (LACP)
 - Cisco ether-channel (static trunk)
 - Maximum 8 trunk groups, up to 8 ports per trunk group
- Supports port mirror (many-to-1)
- Loop protection to avoid broadcast loops
- Supports ERPS (Ethernet Ring Protection Switching)
- Link Layer Discovery Protocol (LLDP)

Quality of Service

- Ingress and egress rate limit per port bandwidth control
- Storm control support
 - Broadcast/Unknown unicast/Unknown multicast
- Traffic classification
 - IEEE 802.1p CoS
 - TOS/DSCP/IP precedence of IPv4/IPv6 packets
- Strict priority and Weighted Round Robin (WRR) CoS policies

802.3bt PoE++ and Advanced PoE Power Output Mode Management

To meet the demand of various powered devices consuming stable PoE power, the GS-4210-Series supports multi-PoE operation modes that include 95-watt 802.3bt type-4 PoE++ mode and 4-pair legacy mode to solve the incompatibility of non-standard 4-pair PoE PDs in the field.

- 95W 802.3bt PoE++ Power Output Mode
- 36W End-span 802.3at PoE+ Power Output Mode

PoE Watts	PoE Operation Mode	Power Output Mode
95W	802.3bt PoE++	(Pins 1, 2, 3, 6 + Pins 4, 5, 7, 8)
36W	End-span 802.3at PoE	(Pins 1, 2, 3, 6)

Built-in Unique PoE Functions for Powered Devices Management

As it is the managed PoE++ switch for surveillance, wireless and VoIP networks, the GS-4210-Series features the following special PoE management functions:

- PD Alive Check
- Scheduled Power Recycling
- PoE Schedule
- PoE Usage Monitoring
- PoE Extension

Intelligent Powered Device Alive Check

The GS-4210-Series can be configured to monitor connected PD status in real time via ping action. Once the PD stops working and responding, the GS-4210-Series will resume the PoE port power and bring the PD back to work. It will greatly enhance the network reliability through the PoE port resetting the PD's power source and reducing administrator management burden.

PD Alive Check

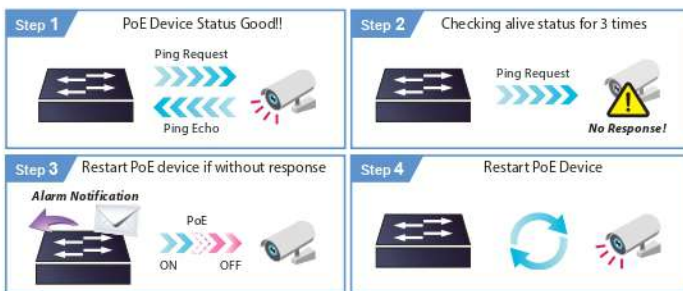

Scheduled Power Recycling

The GS-4210-Series allows each of the connected PoE IP cameras or PoE wireless access points to reboot at a specified time each week. Therefore, it will reduce the chance of IP camera or AP crash resulting from buffer overflow.



Multicast

- Supports IPv4 IGMP snooping v2 and v3
- Supports IPv6 MLD snooping v1, v2
- IGMP querier mode support
- IGMP snooping port filtering
- MLD snooping port filtering

Security

- Authentication
 - Built-in RADIUS client to cooperate with the RADIUS servers
 - RADIUS/TACACS+ login user access authentication
 - DHCP Option 82
- Access control list
 - IPv4/IPv6 IP-based ACL
 - IPv4/IPv6 IP-based ACE
 - MAC-based ACL
 - MAC-based ACE
- MAC security
 - Static MAC
 - MAC filtering
- Port security for source MAC address entries filtering
- DHCP snooping to filter distrusted DHCP messages
- Dynamic ARP Inspection discards ARP packets with invalid MAC address to IP address binding
- IP source guard prevents IP spoofing attacks
- DoS attack prevention

Management

- IPv4 and IPv6 dual stack management
- Switch management interface
 - Web switch management
 - Console and telnet command line interface
 - SNMP v1 and v2c switch management
 - SSHv2, TLSv1.2 and SNMP v3 secure access
- SNMP Management
 - Four RMON groups (history, statistics, alarms and events)
 - SNMP trap for interface link up and link down notification
- User privilege levels control
- Built-in Trivial File Transfer Protocol (TFTP) client
- Static and DHCP for IP address assignment
- System maintenance

PoE Schedule for Energy Savings

Under the trend of energy savings worldwide and contributing to environmental protection, the GS-4210-Series can effectively control the power supply besides its capability of giving high watts power. The “PoE schedule” function helps you to enable or disable PoE power feeding for each PoE port during specified time intervals and it is a powerful function to help SMBs or Enterprises save power and money. It also increases security by powering off PDs that should not be in use during non-business hours.



PoE Usage Monitoring

Via the power usage chart in the web management interface, the GS-4210-Series enables the administrator to monitor the status of the power usage of the connected PDs in real time. Thus, it greatly enhances the management efficiency of the facilities.

802.3at PoE+ Power and Ethernet Data Transmission Distance Extension

In the “Extend” operation mode, the GS-4210-Series operates on a per-port basis at 10Mbps duplex operation but can support 50-watt PoE power output over a distance of up to 250 meters overcoming the 100m limit on Ethernet UTP cable. With this brand-new feature, the GS-4210-Series provides an additional solution for 802.3at/af PoE distance extension, thus saving the cost of Ethernet cable installation.

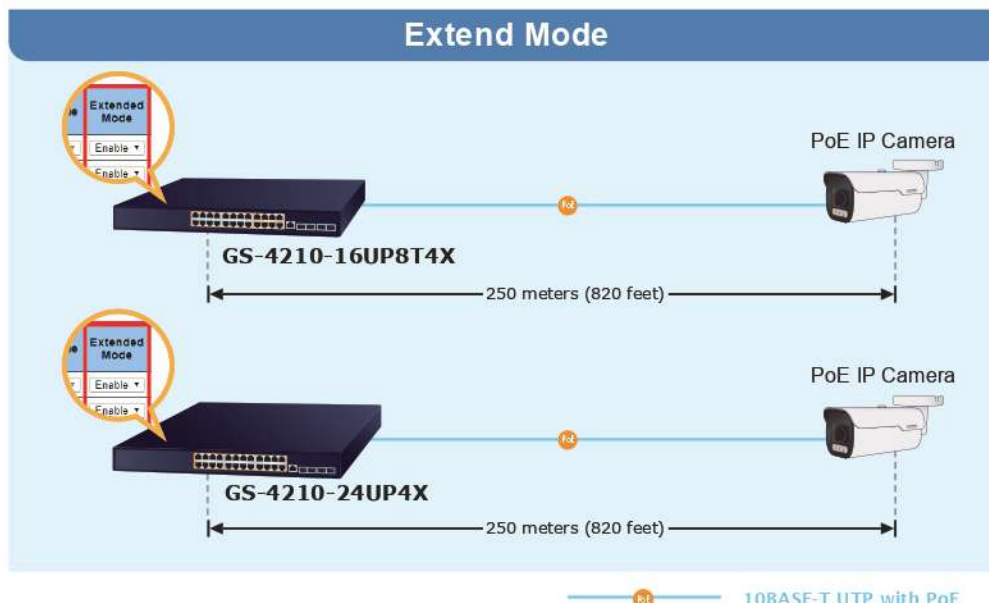

- Firmware upload/download via HTTP/TFTP
- Configuration upload/download through HTTP/TFTP
- Dual images
- Hardware-based reset button for system reboot or reset to factory default
- SNTP Network Time Protocol
- Network Diagnostic
 - SFP-DDM (digital diagnostic monitor)
 - Cable diagnostics
 - ICMPv4/ICMPv6 remote ping
- Link Layer Discovery Protocol (LLDP) and LLDP-MED
- Event message logging to remote syslog server
- PLANET Smart Discovery Utility for deployment management
- PLANET NMS and NMSViewerPro/CloudViewerPro for deployment management

Environment-friendly, Smart Fan Design for Silent Operation

The GS-4210-16UP8T4X and GS-4210-24UP4X feature a rack-mount metal housing, a low noise design and an effective ventilation system. It supports the smart fan technology that automatically controls the speed of the built-in fan to reduce noise and maintain the temperature of the PoE switch for optimal power output capability. They are able to operate reliably, stably and quietly in any environment without affecting their performance.

IPv6/IPv4 Dual Stack Management

Supporting both IPv6 and IPv4 protocols, the GS-4210-Series helps the SMBs to step in the IPv6 era with the lowest investment as its network facilities need not be replaced or overhauled if the IPv6 FTTx edge network is set up.

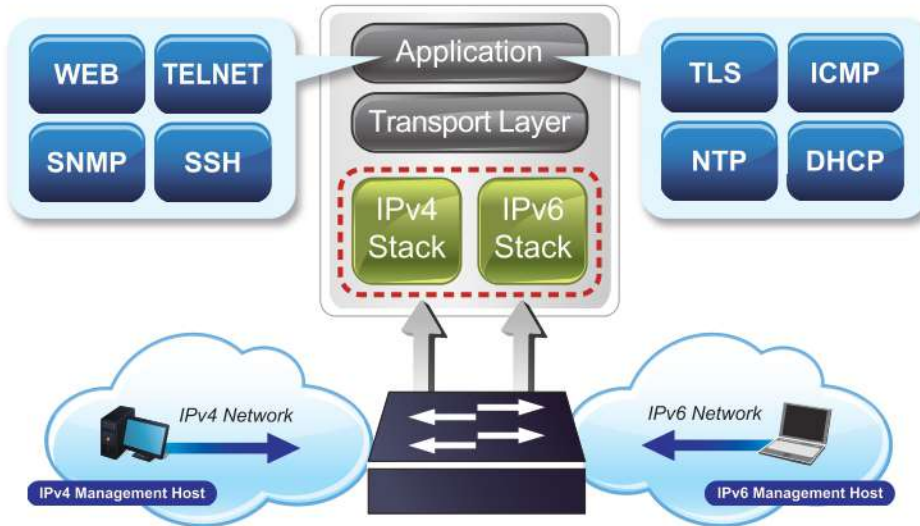

Robust Layer 2 Features

The GS-4210-Series can be programmed for advanced switch management functions such as dynamic port link aggregation, 802.1Q VLAN and **Q-in-Q VLAN**, **Multiple Spanning Tree Protocol (MSTP)**, loop and **BPDU guard**, **IGMP snooping**, and **MLD snooping**. Via the link aggregation, the GS-4210-Series allows the operation of a high-speed trunk to combine with multiple ports, and supports fail-over as well. Also, the **Link Layer Discovery Protocol (LLDP)** is the Layer 2 protocol included to help discover basic information about neighboring devices on the local broadcast domain.

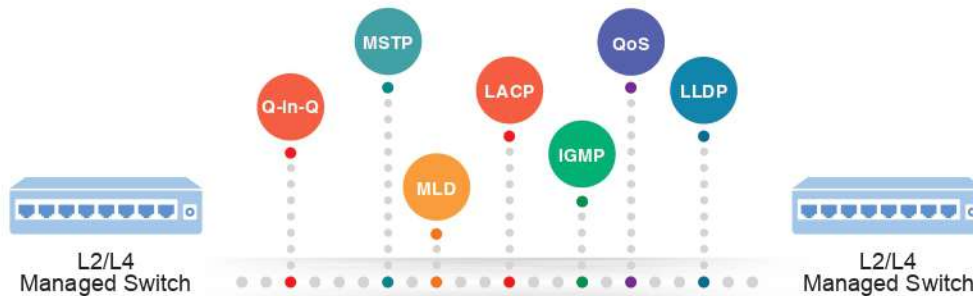

Efficient Traffic Control

The GS-4210-Series is loaded with robust QoS features and powerful traffic management to enhance services to business-class data, voice and video solutions. The functionality includes broadcast/multicast **storm control**, per port **bandwidth control**, IP DSCP QoS priority and remarking. It guarantees the best performance for VoIP and video stream transmission, and empowers the enterprises to take full advantage of the limited network resources.

Powerful Security

The GS-4210-Series offers comprehensive Layer 2 to Layer 4 Access Control List (ACL) for enforcing security to the edge. It can be used to restrict network access by denying packets based on source and destination IP address, TCP/UDP ports or defined typical network applications. Its protection mechanism also comprises 802.1x Port-based user authentication. With the private VLAN function, communication between edge ports can be prevented to ensure user privacy.

Advanced IP Network Protection

The GS-4210-Series also provides **DHCP Snooping**, **IP Source Guard** and **Dynamic ARP Inspection** functions to prevent IP snooping from attack and discard ARP packets with invalid MAC address. The network administrator can now build highly-secure corporate networks with considerably less time and effort than before.

Efficient Management

For efficient management, the GS-4210-Series is equipped with Command line, Web and SNMP management interfaces.

- With the built-in **Web-based** management interface, the GS-4210-Series offers an easy-to-use, platform-independent management and configuration facility.
- For **text-based** management, it can be accessed via Telnet and the console port.
- By supporting the standard SNMP protocol, the switch can be managed via any SNMP-based management software.



Remote Management Solution

PLANET's **Universal Network Management System (UNI-NMS)**, NMSViewer Pro and CloudViewer Pro apps support IT staff by remotely managing all network devices and monitoring PDs' operational statuses. Thus, they're designed for both the enterprises and industries where deployments of PDs can be as remote as possible, without having to go to the actual location once a bug or faulty condition is found. With the UNI-NMS, NMSViewer Pro or CloudViewer Pro apps, all kinds of businesses can now be speedily and efficiently managed from one platform.



Flexibility and Long-distance Extension Solution

The GS-4210-16UP8T4X provides 8 additional Gigabit TP interfaces supporting 10/100/1000BASE-T RJ45 copper for connecting surveillance network devices such as NVRs, Video Streaming Servers, or NAS systems to facilitate surveillance management. Alternatively, through its dual-speed fiber SFP slots, it features 100BASE-FX, 1000BASE-SX/LX, 2.5G, and 10G SFP (Small Form-factor Pluggable) fiber transceivers for uplinking to backbone switches and monitoring centers over long distances. The distance can be extended from 550 meters to 2 kilometers (multi-mode fiber) and up to 10/20/40/60/80/120 kilometers (single-mode fiber or WDM fiber). These models are well suited for enterprise data centers and distribution applications.

Additionally, the GS-4210-24UP4X model is available, featuring 24 10/100/1000BASE-T 802.3bt PoE++ ports and 4 10G SFP ports, without additional TP ports. This model is ideal for scenarios requiring extensive PoE functionality and high-speed fiber connections.

Intelligent SFP Diagnosis Mechanism

The GS-4210-Series supports SFP-DDM (Digital Diagnostic Monitor) function that can easily monitor real-time parameters of the SFP for network administrator, such as optical output power, optical input power, temperature, laser bias current and transceiver supply voltage.

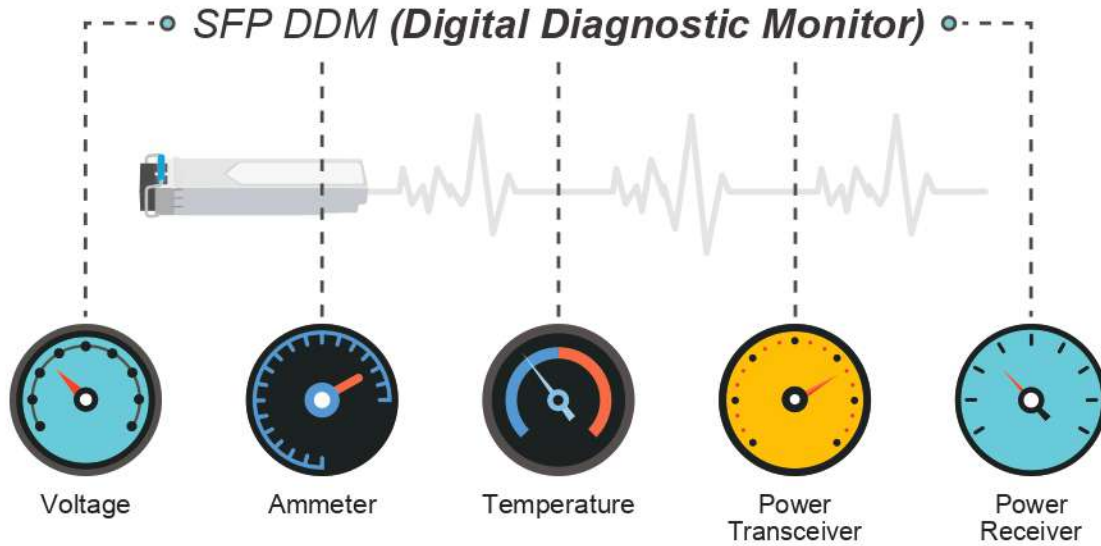

Applications

ITU-T G.8032 ERPS with PoE IP Surveillance System for SMBs/Workgroups

The GS-4210-Series features strong rapid self-recovery capability to prevent interruptions and external intrusions. It incorporates **ITU-T G.8032 ERPS (Ethernet Ring Protection Switching)** technology into customer's automation network to enhance system reliability and uptime. Applying the IEEE 802.3at Power over Ethernet standard, the GS-4210-Series can directly connect with any IEEE 802.3at end nodes like PTZ (pan, tilt, zoom) network cameras and speed dome cameras. The GS-4210-Series can easily build a power that can centrally control a wireless AP, IP camera and VoIP system for SMBs and workgroups in the enterprises with high availability network infrastructure.

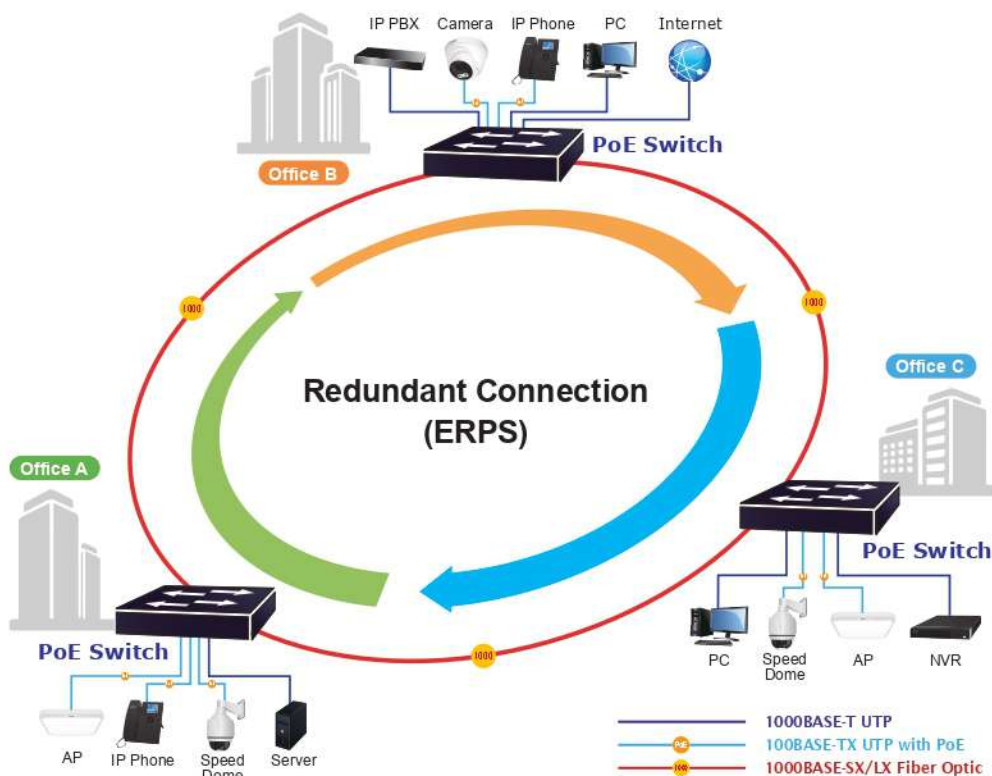

Gigabit 802.3bt PoE++ and PoE+ Network Deployment Solution

PLANET GS-4210-Series can easily build an 802.3bt PoE++ networking solution on the cyber security system for the enterprises. For instance, it can work with the POS system and thin client to perform comprehensive security protection for today's businesses. The GS-4210-Series and 802.3bt PoE++ Splitter-POE-173S, operate as a pair to provide the easiest way to power your Ethernet devices which need high power input. Receiving data and power from the GS-4210-Series, the POE-173S separates digital data and power into three optional outputs (12V, 19V or 24V DC) to non-PoE devices such as laptops, Thin Client, POS System, PTZ (pan, tilt & zoom) network cameras, PTZ speed dome, color touch-screen IP phones, multi-channel wireless LAN access points and other network devices at distance up to 100 meters.

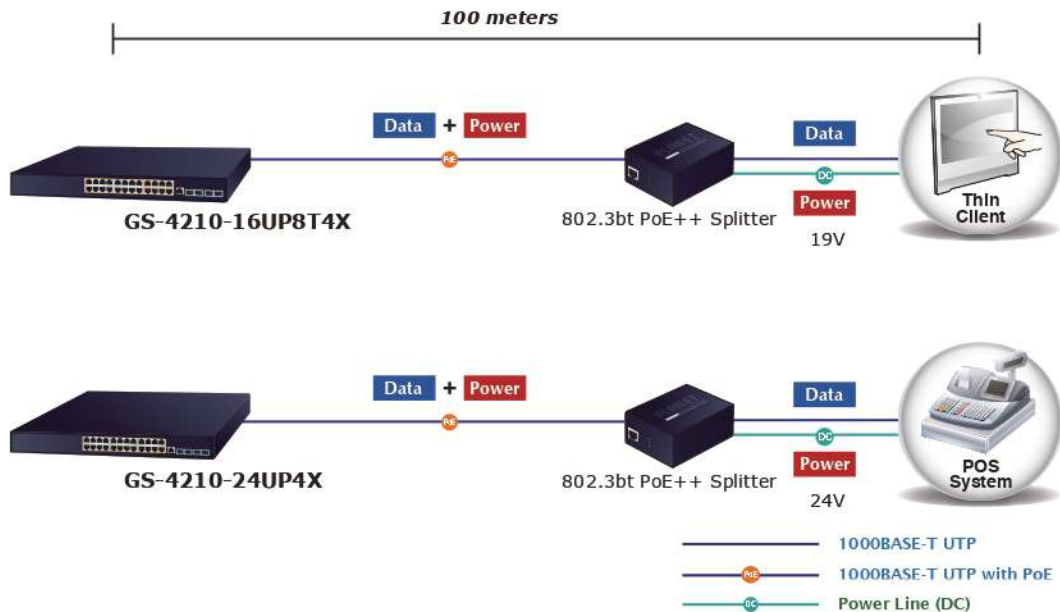

Specifications

Product	GS-4210-16UP8T4X	GS-4210-24UP4X
Hardware Specifications		
Copper Ports	24 10/100/1000BASE-T RJ45 auto-MDI/MDI-X ports	
PoE Injector Port	16 ports with 802.3bt PoE++ injector function (Ports 1 to 16)	24 ports with 802.3bt PoE++ injector function (Ports 1 to 24)
SFP Ports	4 10GBASE-SR/LR SFP+ interfaces (Port XG1 to Port XG4) Backward compatible with 100/1G/2.5GBASE-X SFP transceivers	
Console	1 x RJ45-to-RS232 serial port (115200, 8, N, 1)	
Reset Button	< 5 sec: System reboot > 5 sec: Factory default	
Power Requirements	AC 100~240V, 50/60Hz	
Power Consumption/ Dissipation	Maximum 476 watts/1624.02 BTU (full loading)	Maximum 775 watts/2645.9 BTU (full loading)
Dimensions (W x D x H)	440 x 207 x 44mm	440 x 330 x 44mm
Weight	3182g	4358g
Installation	Rack mount	
Surge Protection	Common mode 4KV, Differential mode 2KV	
ESD Protection	Contact Discharge 6KV DC Air Discharge 8KV DC	
Fan	2 smart fans	4 smart fans
LED	System Power LED (Green) SYS LED (Green) Ports 10/100/1000 RJ45 Ports LNK/ACT (Green) 10G SFP+ Interface LNK/ACT (Green) PoE-in-Use (Amber)	
Fan	2 smart fans	4 smart fans
Switch Specifications		
Switch Architecture	Store-and-Forward	
Switch Fabric	128Gbps/non-blocking	
Switch Throughput@64Bytes	95.23Mpps @64 bytes	

Address Table	16K entries	
Shared Data Buffer	12Mbits	
Flow Control	IEEE 802.3x pause frame for full duplex	
Jumbo Frame	Back pressure for half duplex	
Power over Ethernet		
PoE Standard	IEEE 802.3bt PoE++ PSE Backward compatible with IEEE 802.3at/af PoE PSE	
PoE Power Supply Type	802.3bt : End-span+Mid-span 802.3at : End-span	
PoE Power Output	Port 1 to 16 – 95W (max.)	Port 1 to 24 – 95W (max.)
Power Pin Assignment	802.3bt/UPoE: 1/2(-), 3/6(+), 4/5(+), 7/8(-) 802.3at PoE: End-span: 1/2(-), 3/6(+)	
PoE Power Budget	420 watts (max)	720 watts (max)
Number of 95W 802.3bt Type-4 PDs	4	7
Number of 60W 802.3bt Type-3 PDs	6	12
Number of 802.3at PDs	16	24
PoE Management Functions		
Enhanced PoE Mode	System PoE Admin Mode Consumption Mode/Allocation Mode Temperature Threshold	
Enhanced PoE Mode	Standard/Legacy/UPoE	
Active PoE Device Live Detection	Yes	
PoE Power Recycling	Yes, daily or predefined schedule	
PoE Schedule	4 schedule profiles	
PoE Extended Mode	Yes, max. up to 250 meters	
Layer 2 Functions		
Port Mirroring	TX/RX/both Many-to-1 monitor Up to 4 sessions	
VLAN	802.1Q tagged VLAN 802.1ad Q-in-Q tunneling (VLAN stacking) Protocol VLAN Private VLAN (Protected port) GVRP Management VLAN Up to 256 VLAN groups, out of 4094 VLAN IDs	
Link Aggregation	IEEE 802.3ad LACP and static trunk Supports 8 groups with 8 ports per trunk	
Spanning Tree Protocol	IEEE 802.1D Spanning Tree Protocol (STP) IEEE 802.1w Rapid Spanning Tree Protocol (RSTP) IEEE 802.1s Multiple Spanning Tree Protocol (MSTP) STP BPDU Guard, BPDU Filtering and BPDU Forwarding	
IGMP Snooping	IPv4 IGMP snooping v2, v3 IGMP querier Up to 256 multicast groups	
MLD Snooping	IPv6 MLD snooping v1, v2, up to 256 multicast groups	
QoS	8 mapping IDs to 8 level priority queues - Port number - 802.1p priority - DSCP/IP precedence of IPv4/IPv6 packets Traffic classification based, strict priority and WRR Ingress/Egress Rate Limit per port bandwidth control	
Ring	Supports ERPS, and complies with ITU-T G.8032 Recovery time < 450ms	
Security Functions		
Access Control List	IPv4/IPv6 IP-based ACL/MAC-based ACL IPv4/IPv6 IP-based ACE/MAC-based ACE Max. 256 ACL entries	
Port Security	Built-in RADIUS client to co-operate with RADIUS server RADIUS/TACACS+ user access authentication	
MAC Security	IP-MAC port binding MAC filter Static MAC address, max. 256 static MAC entries	

Enhanced Security	DHCP Snooping and DHCP Option82 STP BPDU guard, BPDU filtering and BPDU forwarding DoS attack prevention ARP inspection IP source guard
Management Functions	
Basic Management Interfaces	Console Web browser Telnet SNMP v1, v2c
Secure Management Interfaces	SSHv2, TLS v1.2, SNMP v3
System Management	Firmware upgrade by HTTP/TFTP protocol through Ethernet network Configuration upload/download through HTTP/TFTP LLDP protocol SNTP PLANET Smart Discovery Utility PLANET NMS/CloudViewerPro
Event Management	Remote/Local Syslog System log
SNMP MIBs	RFC 1213 MIB-II RFC 1215 Generic Traps RFC 1493 Bridge MIB RFC 2674 Bridge MIB Extensions RFC 2737 Entity MIB (Version 2) RFC 2819 RMON (1, 2, 3, 9) RFC 2863 Interface Group MIB RFC 3635 Ethernet-like MIB RFC 3621 Power Ethernet MIB
Standards Conformance	
Regulatory Compliance	FCC Part 15 Class A, CE
Standards Compliance	IEEE 802.3 10BASE-T IEEE 802.3u 100BASE-TX/100BASE-FX IEEE 802.3z Gigabit SX/LX IEEE 802.3ab Gigabit 1000BASE-T IEEE802.3ae 10Gb/s Ethernet IEEE 802.3x Flow Control and Back Pressure IEEE 802.3ad Port Trunk with LACP IEEE 802.1D Spanning Tree Protocol IEEE 802.1w Rapid Spanning Tree Protocol IEEE 802.1s Multiple Spanning Tree Protocol IEEE 802.1p Class of Service IEEE 802.1Q VLAN Tagging IEEE 802.1ab LLDP IEEE 802.3af Power over Ethernet IEEE 802.3at Power over Ethernet Plus IEEE 802.3bt Power over Ethernet Plus Plus IEEE 802.3az for Energy-Efficient Ethernet RFC 768 UDP RFC 783 TFTP RFC 791 IP RFC 792 ICMP RFC 2068 HTTP RFC 1112 IGMP v1 RFC 2236 IGMP v2 RFC 3376 IGMP v3 RFC 2710 MLD v1 RFC 3810 MLD v2 ITU-T G.8032 ERPS Ring
Environment	
Operating Temperature	0 ~ 50 degrees C
Storage Temperature	-10 ~ 60 degrees C
Humidity	5 ~ 95% (non-condensing)

Dimensions

■ GS-4210-16UP8T4X

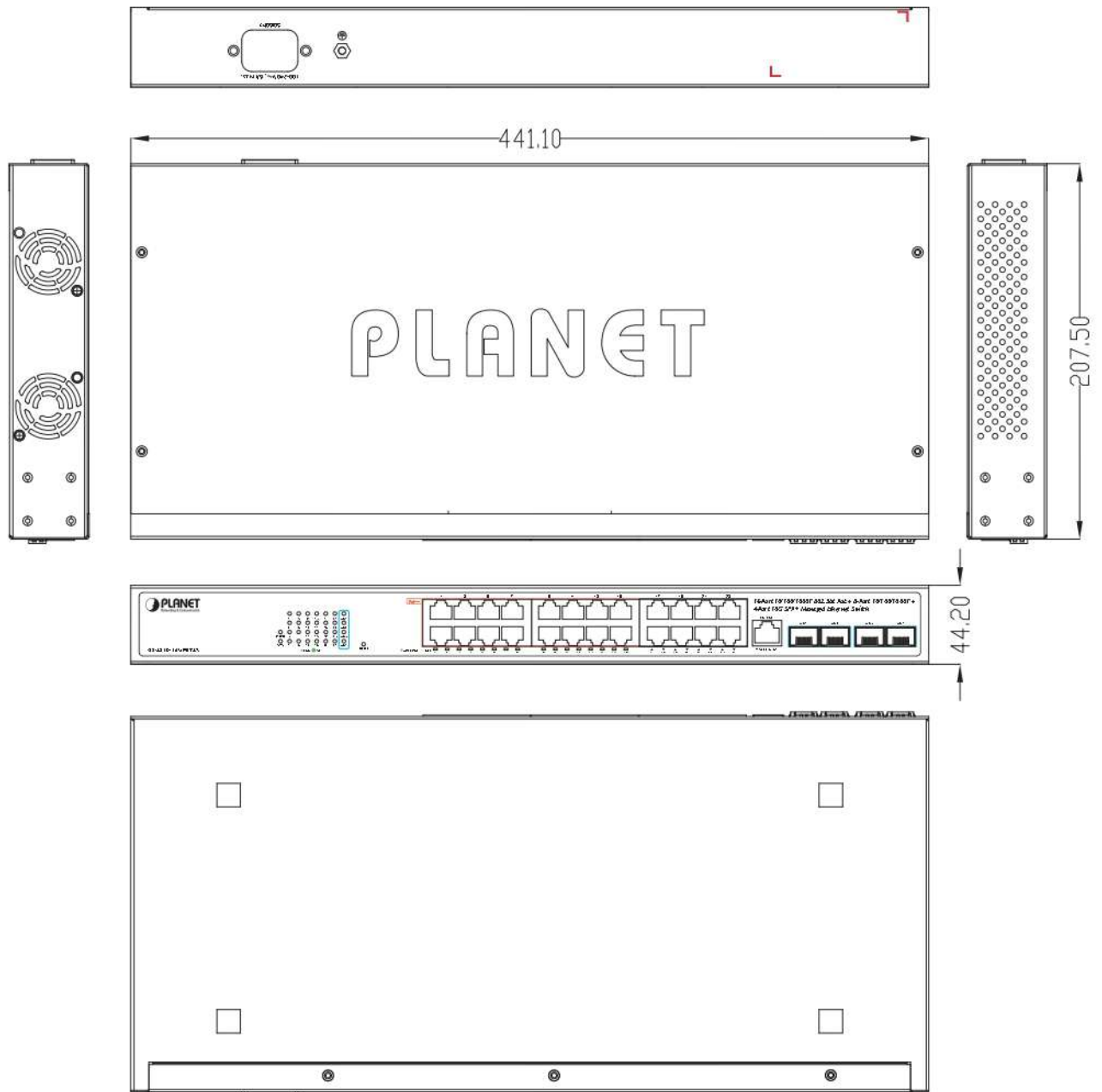

Unit: mm

■ GS-4210-24UP4X

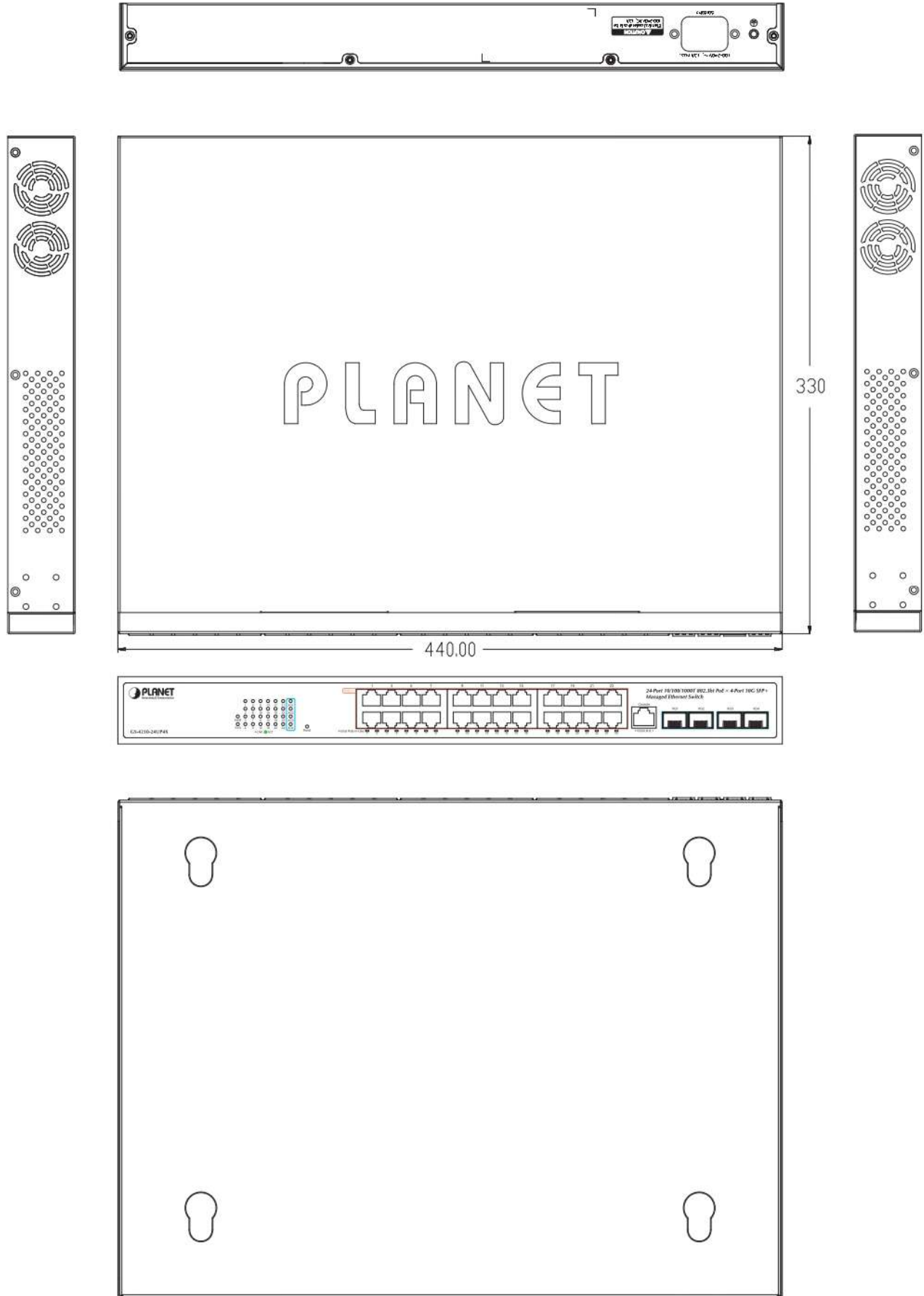

Unit: mm

Ordering Information

GS-4210-16UP8T4X	16-Port 10/100/1000T 802.3bt PoE + 8-Port 10/100/1000T + 4-Port 10G SFP+ Managed Ethernet Switch
GS-4210-24UP4X	24-Port 10/100/1000T 802.3bt PoE + 4-Port 10G SFP+ Managed Ethernet Switch

Related Products

POE-173S	Single-Port 10/100/1000Mbps 802.3bt PoE++ Splitter (12V/19V/24V)
POE-E301	1-Port 802.3bt to 1-Port 802.3bt Gigabit PoE++ Extender
POE-E304	1-Port 802.3bt PoE++ to 4-Port 802.3af/at Gigabit PoE Extender
WGS-E304PT	Industrial 1-Port 10/100/1000T 802.3bt PoE++ to 4-Port 802.3at PoE+ Wall-mounted Extender
XGS-5240-24X2QR	Layer 2+ 24-Port 10G SFP+ + 2-Port 40G QSFP+ Stackable Managed Switch
MTB-Series Module	10GBASE-LR/SR/BX/T Modules
MGB-Series Transceiver	1000BASE-SX/LX SFP Transceiver
MFB-Series Transceiver	100BASE-FX SFP Transceiver

Available SFP/SFP+ Modules

10 Gigabit Ethernet Transceiver (10GBASE-X SFP+)

MTB-LB40	1-Port 10GBASE-BX SFP+ Fiber Optic Module - 40km (TX:1330nm RX:1270nm)
MTB-LA40	1-Port 10GBASE-BX SFP+ Fiber Optic Module - 40km (TX:1270nm RX:1330nm)
MTB-LB20	1-Port 10GBASE-BX SFP+ Fiber Optic Module - 20km (TX:1330nm RX:1270nm)
MTB-LA20	1-Port 10GBASE-BX SFP+ Fiber Optic Module - 20km (TX:1270nm RX:1330nm)
MTB-SR	1-Port 10GBASE-SR SFP+ Fiber Optic Module - 300m
MTB-LR	1-Port 10GBASE-LR SFP+ Fiber Optic Module - 10km
MTB-LA60	1-Port 10GBASE-BX SFP+ Fiber Optic Module - 60km (TX:1270nm RX:1330nm)
MTB-LB60	1-Port 10GBASE-BX SFP+ Fiber Optic Module - 60km (TX:1330nm RX:1270nm)
MTB-RJ	1-Port 10GBASE-T SFP+ Copper Fiber Optic Module - 30m
MTB-LR40	1-Port 10GBASE-LR SFP+ Fiber Optic Module - 40km
MTB-SR2	1-Port 10GBASE-SR SFP+ Fiber Optic Module - 2km
MTB-LR20	1-Port 10GBASE-LR SFP+ Fiber Optic Module - 20km
MTB-LR60	1-Port 10GBASE-LR SFP+ Fiber Optic Module - 60km
MTB-LR80	1-Port 10GBASE-LR SFP+ Fiber Optic Module - 80km
MTB-LA10	1-Port 10GBASE-BX SFP+ Fiber Optic Module - 10km (TX:1270nm RX:1330nm)
MTB-LB10	1-Port 10GBASE-BX SFP+ Fiber Optic Module - 10km (TX:1330nm RX:1270nm)

2.5 Gigabit Ethernet Transceiver (2500GBASE-X SFP)

MGB-2GSR	2.5G SFP Transceiver (Multi-mode, 850nm, DDM, 0~70 degrees C) - 300m
MGB-2GLA20	2.5G SFP Transceiver (Single mode WDM, TX:1310nm RX:1550nm, DDM, 0~70 degrees C) - 20km
MGB-2GLB20	2.5G SFP Transceiver (Single mode WDM, TX:1550nm RX:1310nm, DDM, 0~70 degrees C) - 20km
MGB-2GLR20	2.5G SFP Transceiver (Single mode, 1310nm, DDM) - 20km
MGB-2GLR2	2.5G SFP Transceiver (Single mode, 1310nm, DDM) - 2km

Gigabit Ethernet Transceiver (1000GBASE-X SFP)

MGB-GT	SFP-Port 1000BASE-T Module
MGB-LX	SFP-Port 1000BASE-LX mini-GBIC module - 20km
MGB-SX	SFP-Port 1000BASE-SX mini-GBIC module - 550m
MGB-SX2	SFP-Port 1000BASE-SX mini-GBIC module - 2km
MGB-L40	SFP-Port 1000BASE-LX mini-GBIC module - 40km
MGB-L80	SFP-Port 1000BASE-LX mini-GBIC module - 80km
MGB-L120	SFP-Port 1000BASE-LX mini-GBIC module - 120km
MGB-LA10	SFP-Port 1000BASE-BX (WDM, TX:1310nm) mini-GBIC module - 10km
MGB-LB10	SFP-Port 1000BASE-BX (WDM, TX:1550nm) mini-GBIC module - 10km
MGB-LA20	SFP-Port 1000BASE-BX (WDM, TX:1310nm) mini-GBIC module - 20km
MGB-LB20	SFP-Port 1000BASE-BX (WDM, TX:1550nm) mini-GBIC module - 20km
MGB-LA40	SFP-Port 1000BASE-BX (WDM, TX:1310nm) mini-GBIC module - 40km
MGB-LB40	SFP-Port 1000BASE-BX (WDM, TX:1550nm) mini-GBIC module - 40km
MGB-LA80	SFP-Port 1000BASE-BX (WDM, TX:1490nm) mini-GBIC module - 80km
MGB-LB80	SFP-Port 1000BASE-BX (WDM, TX:1550nm) mini-GBIC module - 80km
MGB-GT	SFP-Port 1000BASE-T Module
MGB-LX	SFP-Port 1000BASE-LX mini-GBIC module - 20km
MGB-SX	SFP-Port 1000BASE-SX mini-GBIC module - 550m
MGB-SX2	SFP-Port 1000BASE-SX mini-GBIC module - 2km
MGB-L40	SFP-Port 1000BASE-LX mini-GBIC module - 40km
MGB-L80	SFP-Port 1000BASE-LX mini-GBIC module - 80km
MGB-L120	SFP-Port 1000BASE-LX mini-GBIC module - 120km
MGB-LA10	SFP-Port 1000BASE-BX (WDM, TX:1310nm) mini-GBIC module - 10km
MGB-LB10	SFP-Port 1000BASE-BX (WDM, TX:1550nm) mini-GBIC module - 10km
MGB-LA20	SFP-Port 1000BASE-BX (WDM, TX:1310nm) mini-GBIC module - 20km
MGB-LB20	SFP-Port 1000BASE-BX (WDM, TX:1550nm) mini-GBIC module - 20km
MGB-LA40	SFP-Port 1000BASE-BX (WDM, TX:1310nm) mini-GBIC module - 40km
MGB-LB40	SFP-Port 1000BASE-BX (WDM, TX:1550nm) mini-GBIC module - 40km
MGB-LA80	SFP-Port 1000BASE-BX (WDM, TX:1490nm) mini-GBIC module - 80km
MGB-LB80	SFP-Port 1000BASE-BX (WDM, TX:1550nm) mini-GBIC module - 80km

Fast Ethernet Transceiver (100BASE-X SFP)

MFB-FX	SFP-Port 100BASE-FX Transceiver (1310nm) -2km
MFB-F20	SFP-Port 100BASE-FX Transceiver (1310nm) - 20km
MFB-FA20	SFP-Port 100BASE-BX Transceiver (WDM,TX:1310nm) -20km
MFB-FB20	SFP-Port 100BASE-BX Transceiver (WDM,TX:1550nm) -20km
MFB-F40	SFP-Port 100BASE-FX Transceiver (1310nm) - 40KM
MFB-F60	SFP-Port 100BASE-FX Transceiver (1310nm) - 60KM
MFB-F120	SFP-Port 100BASE -FX Transceiver (1550nm) - 120km